

Efficient Simulator Based on Meta-Heuristic for FMS and AGV Systems Design and Control

¹Slim Ben Saoud, ¹Amel Jaoua and ²Narjès Bellamine-Ben Saoud
¹L.E.C.A.P./E.P.T. - I.N.S.A.T., B.P. 676, 1080 Tunis Cedex, Tunisia
²RIADI-GDL/ ENSI, Campus Universitaire 2010 la Manouba, Tunisia

Abstract: Flexible Manufacturing Systems (FMS) based on Automated Guided Vehicles (AGV) have emerged as highly competitive manufacturing technologies of the last decade. However, their design and control are complex tasks since the decision problems related to the different system parameters such as sizing and scheduling are usually shown as NP-hard. Nowadays, computer simulation is one of the most commonly used methods for solving these problems. Now, we present a complete simulation tool which allows the design, analysis and control of FMS based on AGV. This tool is composed of three modules: (1) A simulation module which allows the estimation of the user introduced configuration. (2) An optimization module which is based on a meta-heuristic: the simulated annealing. This module is coupled with the simulation one in order to obtain an Executive Information System that is able to generate an optimal configuration. (3) A reactive control system which is based on the concept of real-time simulation and allows dynamic dispatching and routing of different systems inside the global FMS. The different developed modules have been validated by using a typical automated manufacturing system.

Key words: Manufacturing systems, decisions tools, NP-hard, reactive control

INTRODUCTION

With the advent of computers, their ever-increasing capabilities and the rapid developments in automation technology^[1,2], FMS have received increasing attention and have emerged as highly competitive manufacturing strategies of the late twentieth century^[3].

A well-designed FMS is expected to accommodate a variety of incoming jobs as long as the conditions for which the system is designed prevails. This can be performed only by using more efficiently coordination and scheduling of incoming jobs into the system and between the subsystems. Therefore, the success of the FMS lies in the design of the FMS itself as well as in the design of an appropriate scheduling procedure to optimize the required performance measures of the manufacturing systems^[4].

According to these considerations, the design and operation of FMS involve two intricate and interconnected types of decisions that result in the maximum benefit of the system, namely pre-release and post-release decisions. An FMS planning problem, which deals with the pre-arrangements of jobs and tools before the processing begins, comes under the pre-release decisions: the design-related decisions include part types to be produced, the type and size of buffers, the number of pallets and the number and design of fixtures. However, the scheduling problems of the FMS belong to the post-release decision stage: the operation-related problems are input sequence of parts into the system, scheduling parts to machines based upon

alternative routings, sequencing parts on a machine and scheduling material handling devices such as the automated guided vehicles (AGV).

The scheduling problems of FMS have been shown to be Non-deterministic Polynomial (NP) complete problems^[3-5]. Therefore, it is difficult to obtain, with conventional analytical or numerical approaches, an optimal solution. One of the most commonly used methods in recent years for solving scheduling problems has been computer simulation. Simulation models can provide a thorough understanding of the system dynamic behavior and assist evaluation of various system operational strategies. Simulation is a highly flexible tool that can be used effectively for analyzing complex systems. It enables us to model the complex manufacturing systems in detail, whereby the strategies to operate these systems efficiently can be applied in a more realistic environment. It can also handle stochastic problems, for which analytical models have often proved to be inferior or intractable without major simplifications. Simulation is most widely known as a design tool, but in recent years, an increasing number of researchers have been using it to develop various strategies for the operation and the control of manufacturing. The application of simulation technology for real-time scheduling has also been a very popular research topic.

In this research, we present the development of an efficient flexible simulator of FMS systems based on AGV. Using this simulator, the user will be able to make different decisions (pre-release and post-release)

Corresponding Author: Slim Ben Saoud, L.E.C.A.P./E.P.T. - I.N.S.A.T., B.P. 676, 1080 Tunis Cedex, Tunisia

about the arrangement of the FMS and the scheduling of the functioning of its different components (especially the AGV scheduling).

Since an FMS is very complex and has real-time stochastic and uncertain environment, related research on design and operational decisions has been very active during the last decades. Many researchers have focused on the development of techniques and algorithms to determine design or/and control parameters of an FMS according to different performance objectives^[1,3,6].

Handling systems and particularly AGVs have obviously a particular place among the various components of the FMS. Therefore, many research works have been oriented, in the last years, to the design and control of these handling systems, especially the AGV systems. The setting up of an AGV system is confronted to several decisions (similar to those of FMS) which can be classified into two categories, namely design and control decisions. The design of the system is concerned with the guideway layout and the fleet size. The control of the system is related mainly to the dispatching, routing and scheduling of the vehicles^[7-9].

The design and control of FMS based on AGV are critical problems and are usually NP-hard^[10-12]. Therefore, the simulation is often the preferred choice for the study and use of these systems. Many simulators

have been proposed in the literature. However, most of them are either dedicated to a specific production system or specialized for the study of different FMS parameters separately^[3,13].

In this research, we discuss the design of a modular and flexible simulation tool for FMS based on AGV.

THE SIMULATION KERNEL

Simulator design: The first phase of design consists in building a simulation model which defines system activities structure and progression as well as different traffic flows. Then we have chosen to use the UML modeling technique, more especially, the UML activity diagrams^[14].

Figure 1 shows the activity diagram of the global FMS which is composed of manufacturing, handling and storing components. Swim lanes define partitions in the activity diagram that can be bound to objects or object roles.

Once the model built, we implemented it and then we completed it with external procedures which consisted in setting up the complex decision rules such as the routing strategies and the scheduling algorithms.

Implementation and validation: The implementation has been done using SIMAN^[15] language which is oriented to process modeling.

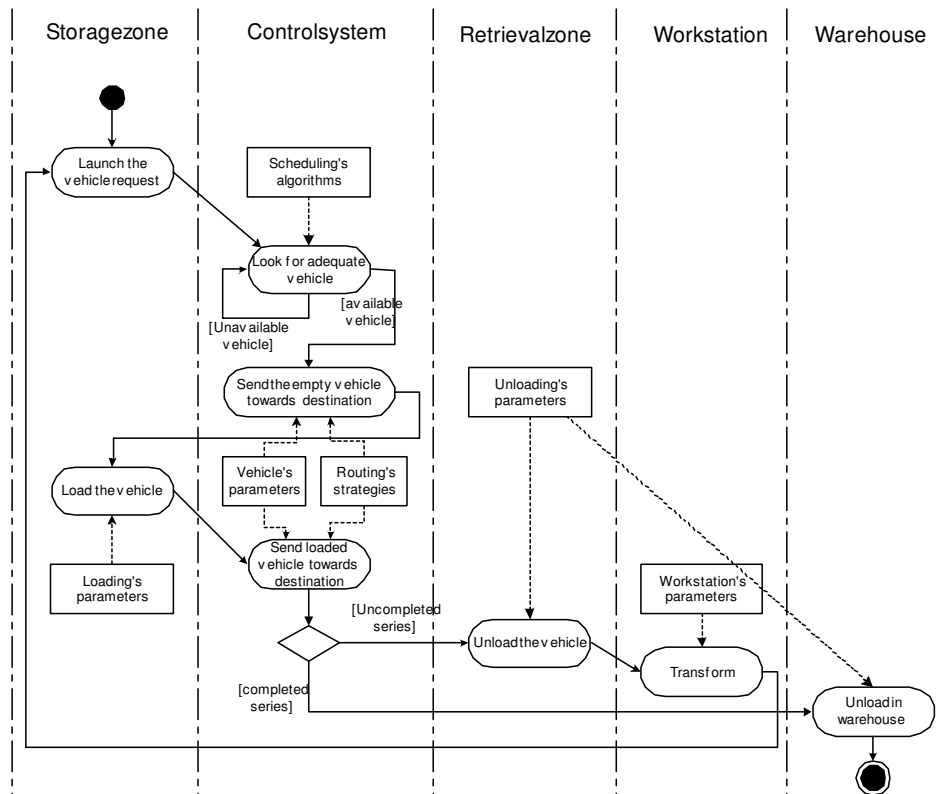

Fig. 1: The activity diagram of the simulator

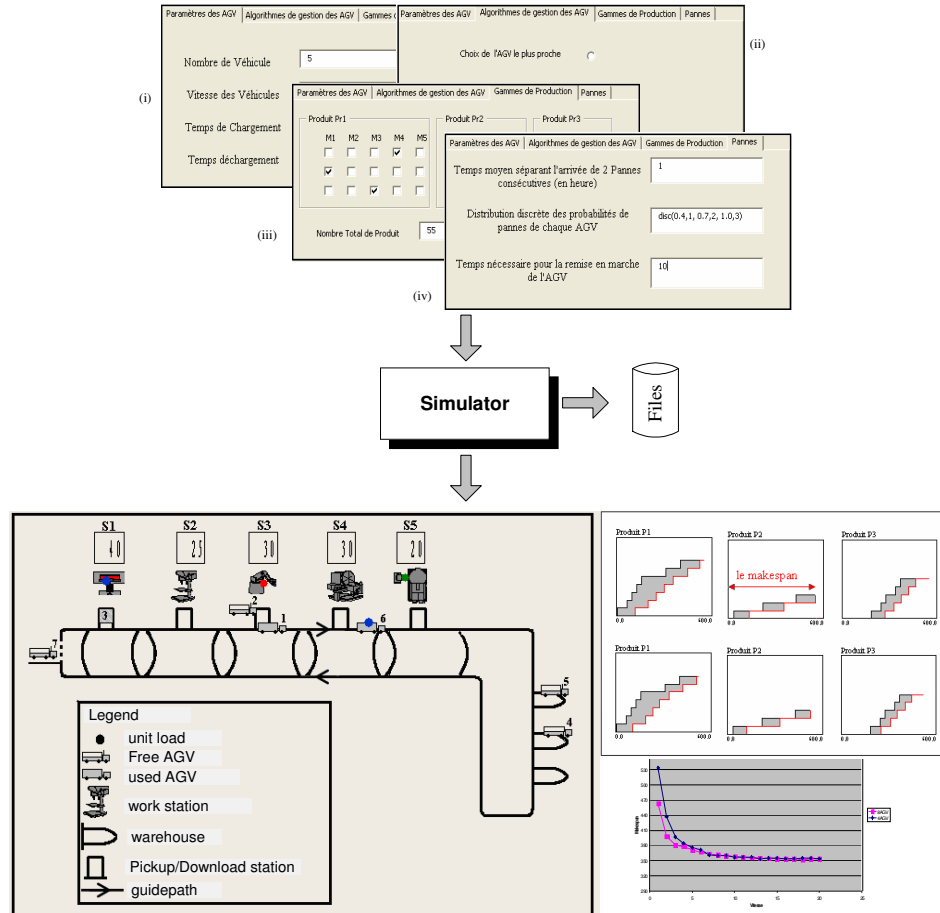

Fig. 2: Overview of the simulator: inputs, outputs and control interfaces

For the purpose of further illustration, we present in this section the obtained simulation models and results for a typical automated manufacturing system.

Overview of the case study: The implemented FMS is composed of five workstations and three warehouses. Each workstation is connected to the unidirectional guidepath network by a pickup and delivery station where the pickups and deliveries are made. This manufacturing system provides the ability to generate three types of products (P1, P2 and P3). Each of them is obtained by visiting several centers before its machining requirements are satisfied. Transports of these products are performed by AGVs at constant speed.

Related AGV scheduling rules: According to the concrete system and to the users' objectives many intuitive rules may be defined such as:

- * A11: Closest free AGV choice: When a workstation W_i requests an AGV, the scheduler selects all free vehicles and then chooses the closest one to W_i .

- * A12: Cyclical AGV choice: In order to avoid an over-exploitation of AGVs, even though the last selected AGV is the closest one it would not be automatically selected: the next mission of that AGV will be agreed only once all other vehicles have performed a number of missions superior or equal to that performed with this vehicle.
- * A13: Preferential Choice: In order to guarantee that all vehicles will not break down simultaneously, we assign numbers to vehicles and choose always the smallest numbers so that the AGVs with the smallest numbers will be the most used. Consequently, breakdowns would be spread on time and their maintenance would be easier to manage.

This description is not exhaustive, additional rules may be defined.

Description of the obtained FMS simulator: As shown on Fig. 2, the simulator provides user interfaces for input, output and control variables and parameters setting.

The user can interactively choose: i- the AGV parameters (number, speed and load/unload delays), ii- the scheduling rule, iii- the machining requirements for each product and iv- the breakdown parameters (frequency, delays, etc).

The simulator can generate a main display showing the real time simulation evolution of the FMS and provides information about different component states. It also offers additional outputs such as graphics, tables of values and backup files to trace the whole simulation execution.

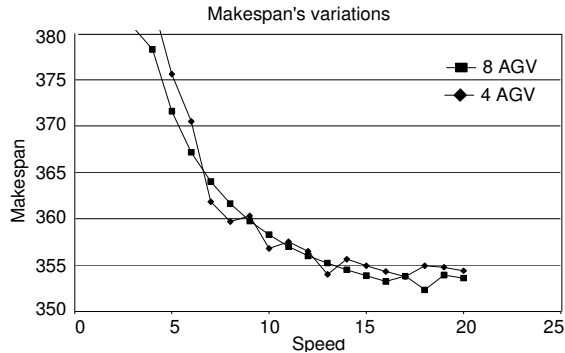

Fig. 3: Makespan variation curves according to the speed of AGVs

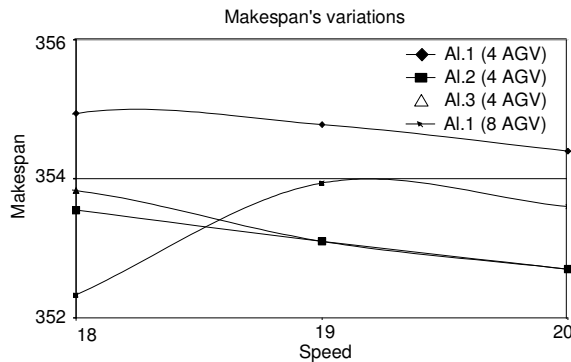

Fig. 4: Makespan variations function of the AGVs speed and scheduling algorithm

Virtual experiments and simulation results: In this section, we present a use case in order to determine the adequate speed and number of AGVs which allow having good performances. During the performed tests, we chose the makespan as performance criteria; the makespan corresponds to the cumulative lead time of the overall production schedule for on-time shipment and should be minimized.

Figure 3 shows the obtained curves representing, for two values of AGVs number (4 and 8), the evolution of the makespan as a function of the speed value.

We notice that the vehicle speeds increase does not improve systematically the performance criteria (makespan).

On Fig. 4, we compare the obtained results using the different scheduling rules (AI1, AI2 and AI3).

We notice also that increasing the vehicle number does not automatically assure the improvement of the performance criteria. In some cases, it is enough to change the scheduling of the algorithm to have a better Makespan.

The simulator can be used to analyze different configurations and provide numerical results, useful for decision makers of design and operational parameters. However, we notice that there is no evolution rule of the decision variables vector which could guarantee the improvement of the performance criteria. Additionally, the simulator allows us only to estimate solutions but does not produce other optimal ones. Therefore, in order to enhance these tool performances and ability to generate other configurations with better performances, we developed (as shown on the following section) an Executive Information System (EIS).

THE EXECUTIVE INFORMATION SYSTEM (EIS)

In order to be able to suggest to the decision makers solutions improving the system performances, we extend our simulator to obtain an EIS by coupling it with an optimization module and modifying the interface in order to include appropriate parameters related to optimization methods (Fig. 5).

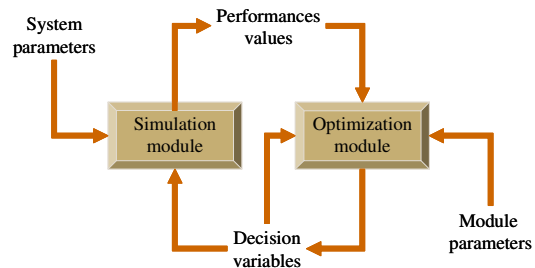

Fig. 5: Global architecture of the EIS system

Optimization principle: In the simulation/optimization problem, the simulation model is complex and the performance measure M cannot be expressed analytically according to the simulation variables. Indeed, for each decision variable vector V , the value of the objective function $M(V)$ is a simulation result. The simulation model supplies the value of the objective function and the optimization module determines, according to the supplied result and the previous values of the decision variables, the next decision variables for testing. So we opted for the simulated annealing algorithm which allows resolving the problem of local minimum.

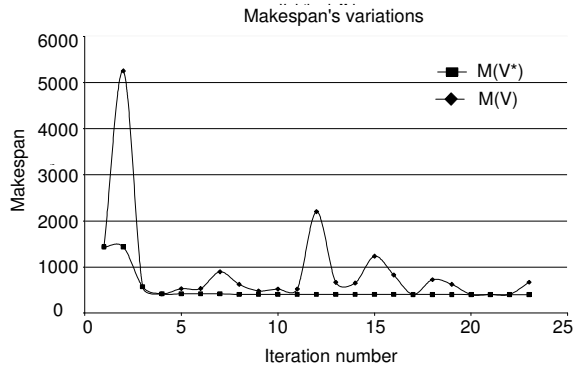

Fig. 6: Evolution of the makespan by using the simulated annealing method

In fact, the principle of the obtained EIS use can be summarized by the following steps:

- * Once the decision maker launches the simulator, the optimization module is activated;
- * The decision maker fills up the user interface with both simulator starting parameters (as before) and annealing parameters;
- * The simulator executes the whole AGV scheduling process and then sends to the optimization module the configuration and the objective function;
- * The optimization module applies the annealing algorithm, then decides whether the solution is optimal or not: if it is optimal, it backups the configuration; if not, i.e. if the temperature is greater than the minimal temperature, it suggests a new configuration and launches automatically a new simulation.

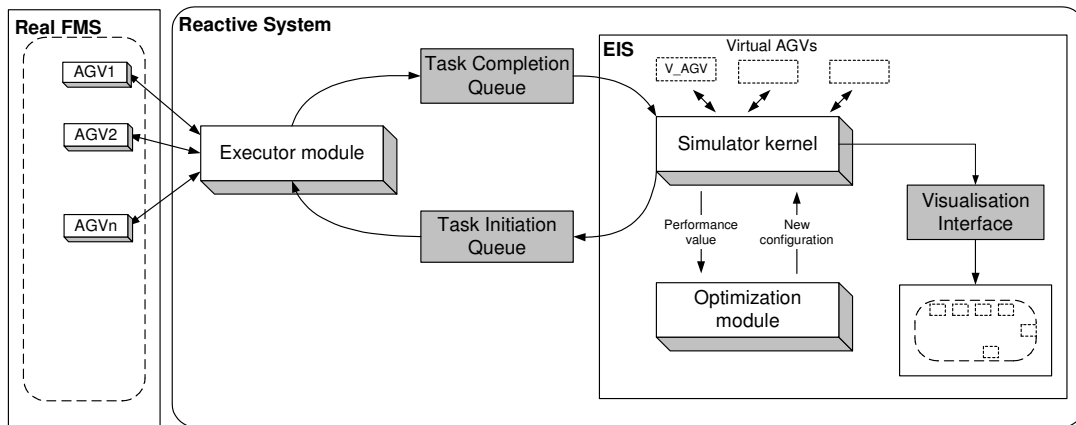

Fig. 7: Global architecture of the RCS

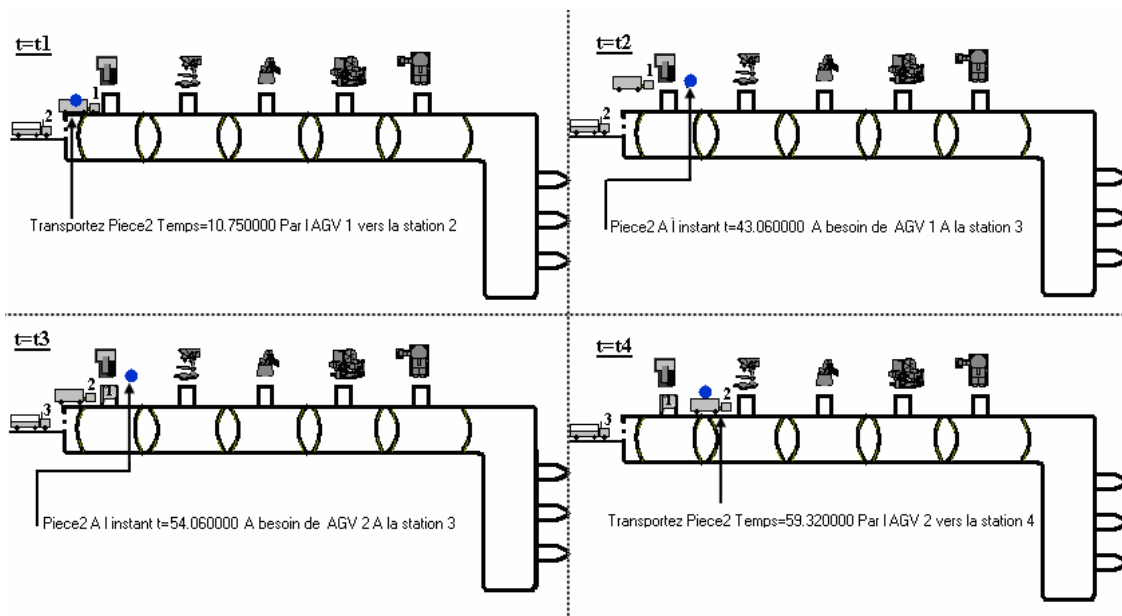

Fig. 8: System reactivity in the case of AGV breakdown

Consequently, this system would progressively and autonomously check configurations till reaching the optimal one under the decision maker control.

Validation: The EIS has been tested with the typical FMS of the previous section and by using the makespan $M(V)$ as the performance criterion. While $V=(V_1, V_2, V_3)$, where: V_1 =number of AGVs, $V_1 \in [1,12]$; V_2 =speed of AGVs, $V_2 \in [1, 50]$ and V_3 =scheduling rule, $V_3 \in [1, 3]$.

We obtained the results of Fig. 6, which draws the evolution of the makespan as function of iterations of the annealing algorithm using different temperatures. This figure shows two curves: $M(V)$ referring to typical used configuration of production and $M(V^*)$ representing the optimal configuration. Consequently, we conclude that by using the simulated annealing, the system may converge towards better solutions.

However, the handling system based on AGVs is confronted, during its functioning, with unpredictable events which should be considered in the scheduling procedure. In fact, the simulator restores predictive scheduling which aims to foresee the system execution modalities by basing itself on preliminary hypotheses concerning the evolution of the vehicles situation in the system.

With the aim of taking into account these unpredictable events, we conceived a reactive control system. So, we transformed predictive scheduling into dynamic real time scheduling.

THE REACTIVE CONTROL SYSTEM (RCS)

Design of the RCS: Given the multiple disturbances and hazards to which the handling system based on AGVs is faced, it becomes crucial to get a dynamic scheduling. So, we developed a reactive system to ensure the real-time AGV scheduling. To design such a reactive system, we based our work on the concept of Real-Time Simulation^[16].

The developed system is therefore composed of the previous EIS to which we added a new executor module (Fig. 7).

With this architecture, the executor module plays a role of interface between the EIS and the real manufacturing system: it allows on the one hand the transmission of orders generated with the EIS to the AGV and on the other hand the reception of messages transmitted by the real FMS to the EIS.

Implementation and virtual validation of the RCS: We set up the communication protocol between processes with Dynamic Link-Libraries (DLL) written in Visual C++, which we associated to our simulator.

To be able to communicate with the real system, we defined the parts of the simulator which are going to communicate with it. Finally, to set up communication between the various modules we created a client application which uses the Transmission Control Protocol (TCP); and we developed another module to simulate actions resulting from the real system. Fig. 8 shows the reactivity of the control system to an external event which represents (as an example) AGVs breakdowns.

We suppose that the vehicle 1 breaks down before reaching the station 3 (at $t=t_2$), so the decision-maker module is going to react to this event and sends a request for another vehicle (the vehicle 2, at $t=t_3$) to serve this station. As a result, the vehicle 2 is going to continue till the second workstation (at $t=t_4$).

CONCLUSION

In this research, we designed and developed a simulation and reactive monitoring tool which allows supporting decision makers of FMS systems based on AGV. Works have been done according to a progressive method. Firstly, we developed an EIS system dedicated to the analysis and design of FMS based on AGV. This system is composed of two modules: (1) a modular simulation module which allows the easy obtaining of simulation models specific to the studied FMS and the providing of useful numerical results to the decision makers; (2) an optimization module based on a meta-heuristic which allows obtaining optimal configurations with better performances.

The EIS system has been validated successfully with a typical FMS and the obtained results confirm that it can contribute efficiently to the analysis of new algorithms, the support of decision makers, therefore, to the elaboration of optimal decisions concerning the FMS parameters.

Although this tool allows obtaining optimal configuration for the FMS, it is unable to consider different unpredictable events such as the breakdowns of vehicles and the congestion. Hence, it becomes necessary to provide a reactive system based on real time dynamic view of the system state.

To develop this system, we added to the EIS tool an executor module which allows taking into account and in real-time different unpredictable and disturbing events. The developed reactive tool has been validated with virtual experiments and the obtained simulation results are very satisfactory.

In future works we will focus on the validation of this tool on a real manufacturing process by controlling AGV with wireless systems. We intend also to integrate other scheduling and optimization algorithms and

extend our work with robotics simulation, which would lead us to the digital factory.

REFERENCES

1. Park, T., H. Lee and H. Lee, 2001. FMS design model with multiple objectives using compromise programming. *Intl. J. Product. Res.*, 39: 3513-3528.
2. Zaremba, M.B. and G. Morel, 2003. Integration and control of intelligence in distributed manufacturing. *J. Intell. Manufact.*, 14: 25-42.
3. Chan, Felix T.S. and H.K. Chan, 2004. A comprehensive survey and future trend of simulation study on FMS scheduling. *J. Intell. Manufact.*, 15: 87-102.
4. Saravana Sankar, S., S.G. Ponnambalam and C. Rajendran, 2003. A multiobjective genetic algorithm for scheduling a flexible manufacturing system. *Intl. J. Advanced Manufact. Technol.*, 22: 229-236.
5. Shin, J. and H. Cho, 2001. Planning and sequencing heuristics for feature-based control of holonic machining equipment. *Intl. J. Flexible Manufact. Syst.*, 13: 49-70.
6. Rai, R., S. Kameshwaran and M.K. Tiwari, 2002. Machine-tool selection and operation allocation in FMS: solving a fuzzy goal-programming model using a genetic algorithm. *Intl. J. Product. Res.*, 40: 641-665.
7. Lee, K.K., W.C. Yoon and D.H. Baek, 2001. Generating interpretable fuzzy rules for adaptive job dispatching. *Intl. J. Product. Res.*, 39: 1011-1030.
8. Qiu, L., W.J. Hsu, S.Y. Huang and H. Wang, 2002. Scheduling and routing algorithms for AGVs: A survey. *Intl. J. Product. Res.*, 40: 745-760.
9. Anwar, M.F. and R. Nagi, 1996. Integration of just-in-time production and material handling for an assembly environment. *Proc. 5th Industrial Eng. Res. Conf.*, Minneapolis.
10. Tan, K.K. and K.Z. Tang, 2000. Simulation of an evolutionary tuned fuzzy dispatching system for automated guided vehicles. *Proc. 2000 Winter Simulation Conf.*, pp: 1339-1343.
11. Anwar, M.F. and R. Nagi, 1998. Integrated scheduling of material handling and manufacturing activities for just-in-time production of complex assemblies. *Intl. J. Product. Res.*, 36: 653-681.
12. Hertz, A., Y. Mottet and Y. Rochat, 1996. On a scheduling problem in a robotized analytical system. *Discrete Applied Math.*, 65: 285-318.
13. Mukkamala, P.S., J.S. Smith and J.F. Valenzuela, 2003. Designing reusable simulation modules for electronics manufacturing systems. *Proc. 2003 Winter Simulation Conf.*, pp: 1281-1289.
14. Douglass, B.P., 2004. *Real Time UML: Advances in the UML for Real Time Systems*. Addison Wesley.
15. Peden, C.D., 1982. *Introduction to SIMAN*. Syst. Model Corporation, State College, Penn.
16. Smith, J.S., 2001. *Simulation system for real-time planning, scheduling and control*. Texas A&M University.