

Original Research Paper

Numerical Investigation of the Impact of Punch Speed on the Deep Drawing of Square Aluminum Sheet Using Finite Element Method

¹Ehsan Hedayati, ²Arefeh Hedayati, ¹Mohammad Vahedi and ³Shirko Faroughi

¹Department of Mechanical Engineering, College of Technical Engineering, Saveh Branch, Islamic Azad University, Saveh, Iran

²Department of Industry Engineering, College of Technical Engineering, Saveh Branch, Islamic Azad University, Saveh, Iran

³Faculty of Mechanical Engineering, Urmia University of Technology, Urmia, Iran

Article history

Received: 26-11-2024

Revised: 11-12-2024

Accepted: 12-12-2024

Corresponding Author:

Ehsan Hedayati

Department of Mechanical

Engineering, College of Technical
Engineering, Saveh Branch, Islamic
Azad University, Saveh, Iran

Email: hedayati.uast.ac@gmail.com

Abstract: This study examines the Deep Drawing Process (DDP) of square aluminum sheets, emphasizing its applications across various industries, including medical devices. The process is simulated using ABAQUS finite element software, analyzing the effects of parameters like punch speed and friction on the final results. One of the important aspects of this study is the use of the Forming Limit Diagram (FLD) criterion to determine the rupture point of the sheet during the DDP. This criterion allows us to assess the deformation of the sheet and examine the possibility of predicting and preventing rupture at different stages of the deep drawing. The results obtained from the simulations show that reducing the punch speed in the DDP of aluminum leads to a greater thickness of the final part at the same depth produced. In other words, decreasing the punch speed results in an increased duration of the DDP, which aids in producing parts with greater depth. This finding is particularly important in the manufacture of components featuring intricate shapes that demand high precision. Moreover, the research results indicate that by reducing the frictional interaction between the holder and sheet, as well as increasing the frictional interaction between the sheet and die, it is possible to produce parts with greater depth and less wrinkling and tearing. This outcome suggests that optimizing lubrication conditions and appropriately designing various parts of the die can significantly enhance the final quality of the produced components and the efficiency of the DDP.

Keywords: Deep Drawing, Aluminum, Friction, FLD Failure Criterion, Wrinkling and Rupture

Introduction

The deep drawing process is an essential technique used in various industries, including medical applications, for manufacturing a diverse range of metal components. In this process, by applying tensile forces, plastic changes are created in the metal to shape the desired piece.

This process is carried out based on experience and experimentation, but for improvement and better control of the process, scientific analyses are needed. Generally, simple assumptions and equations are used to prevent complexities in this process. This process is considered one of the most critical steps in the industry and medical, holds a special place in medical and industrial device

production, and has been the subject of research and investigation by many researchers for a long time.

Several different approximate numerical and analytical methods exist for analyzing metal forming processes. In recent years, the Finite Element Method (FEM) has become increasingly popular among both industrial practitioners and researchers, particularly in the field of metal-forming processes such as DDP. Hessenberg (1954) was the first person to study and analyze the DDP using theoretical methods.

(Chung and Swift, 1951) Simulated DDP of a square cup using a flat blank, calculating the initial blank dimensions to achieve the final cup. They were among the first to use the FEM to simulate DDP of parts.

Individuals like (Jensen *et al.*, 1998) conducted various studies on wrinkling in the DDP techniques to various models without the inclusion of a drawbead, with the following results:

- At the end and bottom of the drawing area, as no cold work is done, the draw is nearly zero and generally zero
- Circular flow lines remain circular at the end region and the elements on the initial surface move with the same radius of curvature until reaching the die edge, becoming parallel to the die edge radius first and then parallel to the die body when reaching the die body
- Flow lines in a shell indicate that metal movement is uniform

Hu *et al.* (2002) used the FEM to analyze the DDP of circular, box-shaped, and various automotive body parts. In this method, the entire process of sheet metal forming in the die is divided into a large number of stages. After various analyses, it was concluded that achieving the desired forming results is possible only when the following conditions are met:

- Local stresses that could lead to sheet damage exceed a certain threshold
- Punch movement reaches a defined value
- The contour of the sheet intersects a point on the die radius

Yang and Kim (1986) investigated the three-dimensional relationship of a solid-wax-mixed heterogeneous sheet metal following Hill's law. The aim of this analysis was to examine the necking location in the DDP process and the initiation of cracks in the circular diaphragm, with the results of this analysis closely matching the experimental result. Sowerby *et al.*, (1986) proposed a method for calculating surface strains in flange parts subjected to the DDP with a round cross-section. They in this method registered the positions of nodes, the entire surface of the flange, and the initial sheet relative to a reference coordinate axis. Their results showed that the change in the relationship of the flange assuming a round cross-section of the sheet was uniform and wrinkling in it compared to assuming a non-round cross-section was very minimal. Hosford and Caddell (2011) used a method attributed to Whitley to analyze the tensile stress of cup-shaped components with flat bottoms. In this method, two regions are considered for the deformation relationship; the flange region where the most significant deformation occurs, and the wall region which must withstand sufficient force to induce deformation in the flange. Two independent coordinate systems are defined for these two regions. Using simplifications and modifications, this method extracted precise analytical relationships for maximum tensile stresses in elements under tension.

Sheng *et al.* (2008) conducted research on multi-stage DDP dies using the FEM and designed symmetrical die performances in this process. Under and his colleagues (Önder and Tekkaya, 2008) studied the influence of tool cross-sectional area in three processes of conventional DDP, hydro-mechanical DDP and high-pressure DDP using experimental and FEM. Their results showed that optimal parameters had a strong dependence on tool geometry and these optimal parameters should be determined for each cross-sectional area in each process.

Amini also studied the hydro-mechanical DDP using experimental and FEM (Amini *et al.*, 2024). They used an innovative variable dependent on the yield limit curve in their research. With this variable, the output information from the FEM predicted the occurrence of defects or the accuracy of the process with higher precision.

Singh and Gupta (2010) used a novel data analysis method called Support Vector Regression to predict the thickness of the shell in the hydro-mechanical DDP. The experimental test results confirmed the FEM and a neural network was used to predict the thickness of the shell under test. According to the results obtained, the Support Vector Regression method had higher accuracy.

Kim (2010) used a combination of experimental method and FEM to determine optimal process parameters in the thermal gradient shape forming of aluminum alloy sheets. His results showed that higher temperature for the mold and lower temperature for the blank are desirable for achieving greater formability.

Zhang *et al.* (2000) used the FEM to investigate defects such as thinning, cracking, and wrinkling in the DDP hydro-mechanical process on a square-shaped cup. According to his results, thinning occurred in the first third of the punch movement during forming, while wrinkling occurred in the second half. Overall, there has been very little scientific activity and research in this area and many designers avoid designing square parts and prefer to use bending and edge bonding methods, often resorting to trial and error, resulting in significant waste and costs. Considering the importance of this issue, this article discusses and investigates the effect of punch speed on the DDP of square steel cups.

Materials and Methods

Although the study of the DDP continues to rely primarily on empirical findings, important parameters of this process such as the relationship and size of the initial sheet, die clearance, tensile force, friction, and punch speed are generally obtained through experience and trial and error by designers. In the meantime, friction and the punch speed are very important parameters in the DDP, as friction and speeds can be decisive, and using appropriate lubrication and viscosity can have a significant impact on friction and pulling speed. During DDP, softer materials

tend to crack and tear at high friction and drawing speeds. Therefore, in DDP, soft metals such as aluminum and heat-resistant alloys, the punch speed and friction become more important. In order to save time and costs, using numerical simulation methods, which are also capable of providing acceptable accuracy, is very suitable for studying the desired process. In this study, the Abaqus 6.14 software has been used to analyze and simulate the DDP of aluminum. The dimensions of the die, matrix, holder, punch, and sheet metal are mentioned in Figs. (1-2) are given. In the current study, the material of the die, mold, and holder is steel 304 L and the material of the sheet metal is aluminum, and their mechanical properties are listed in Table (1) (Cser, 1991). The thickness of the sheet is 1mm. To investigate the location of sheet metal fracture in the DDP, the Forming Limit Diagram (FLD) damage initiation criterion is used, as shown in Fig. (3) (Cser, 1991).

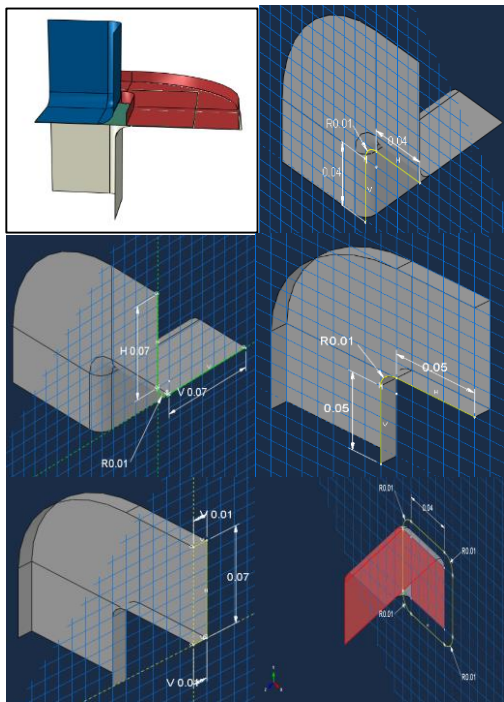

Fig. 1: The three-dimensional view of the mold

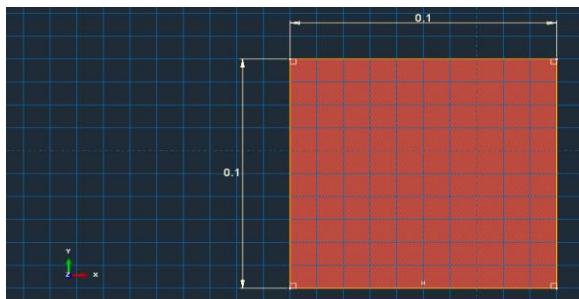

Fig. 2: The two-dimensional view of the sheet metal

The FLD is essential for predicting necking in sheet metal forming. Limit strains indicate the maximum strains sheet metals can withstand before necking occurs (Safdarian *et al.*, 2015). The FLD graphs these limit strains against principal strains. In this context, 'major' and 'minor limit strains' refer to the maximum and minimum in-plane principal limit strains, respectively. The major limit strain is typically on the vertical axis, while the minor limit strain is on the horizontal axis (Kolahdooz *et al.*, 2017), as shown in Fig. (4) (Paul *et al.*, 2013). Damage initiation on the FLD is defined by the ratio of the current major principal strain (ϵ_{major}) to the major limit strain (Abaqus, 2017), assessed against the current minor principal strain (ϵ_{minor}) (Safdarian *et al.*, 2015). For example, for the deformation state at point A in Fig. (4), the damage initiation criterion is assessed as follows.

Table 1: Mechanical properties for mold and sheet metal

Mechanical properties	Steel 304L	Aluminum
σ_{us} , MPa	564	520
σ_y , MPa	210	477
ϵ_f , %	58	17
E , GPa	200	71.7
Charpy Impact, J	216	800
Density, (kg/m ³), ρ	7800	2810
Poisson ratio, ν	0.29	0.33

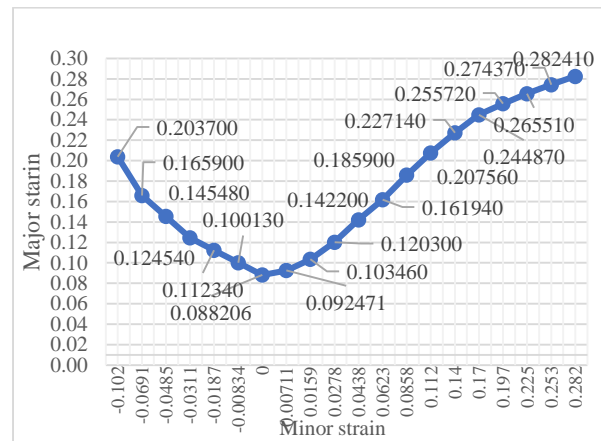

Fig. 3: FLD model parameters for aluminum

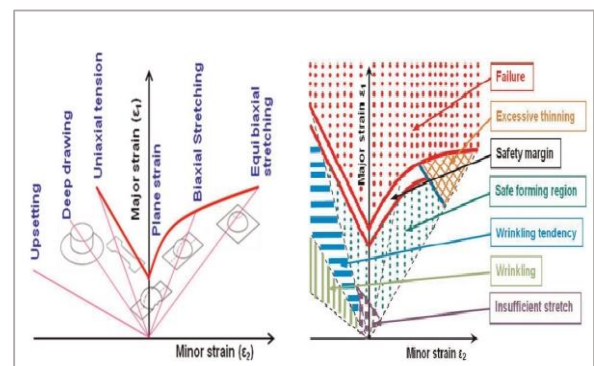

Fig. 4: Schematic representation of FLD (Paul *et al.*, 2013)

Problem Modeling and Boundary Condition of the Numerical Model

Due to Divergence issues, an explicit method has been used instead of an implicit method for analysis and modeling, and given that the DDP is quasi-static, in the STEP module of Abaqus software, explicit dynamic analysis has been used. Considering the material of the work piece, a time interval of 0.06 sec for the DDP has been considered in the aluminum sheet. In order to reduce computational costs, a quarter of the model has been designed .Given the comparative nature of the current research, the friction in the DDP in the Abaqus software module has been considered to be zero. Also, the type of contact effect between the part, blank holder, punch, and die in this process is assumed to be general. The boundary conditions and loading are shown in Fig. (5). To calculate the speed range of the punch in the DDP for all materials, the Taylor equation can be used, which is presented analytically as Eq. (1) (Abaqus, 2017):

$$0 < v_{punch} \leq 0.001 \times \sqrt{\frac{E}{\rho}} \tag{1}$$

where, v_{punch} , E , and ρ are punch speed, is Young's modulus of the workpiece material (Gürin and Karaağaç, 2015) and the density of the material respectively. Therefore, this problem is investigated in 4 different model cases and the results of changing the friction and punch speed parameters for aluminum sheets are examined.

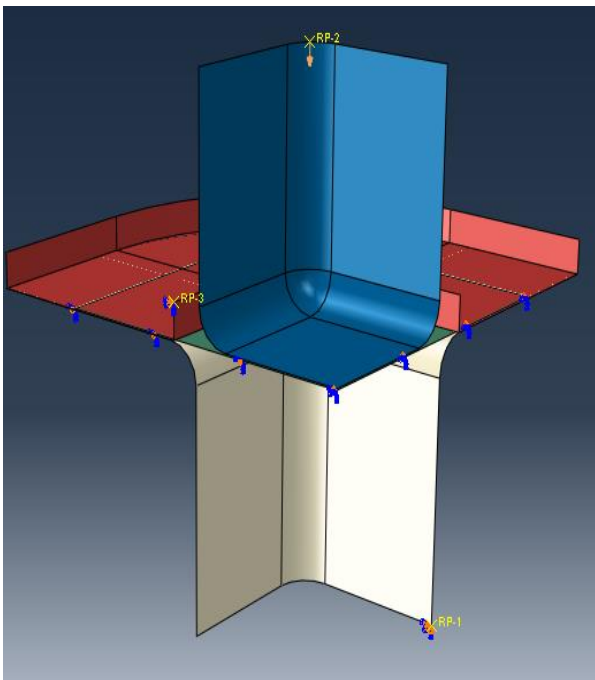

Fig. 5: Boundary condition of the numerical model

Solution Convergence in on Mesh Size

The model is three-dimensional and the type of element used in the die, mold, and holder is R3D4, while in the sheet metal, it is S4R. Considering that the material of the die, mold, and holder are steel 304, are considered solid in the modeling. The mesh should be evaluated not only for its shape but also for its size. To achieve this, convergence of solutions must be examined, which is crucial for ensuring the accuracy of the results. When examining the convergence of the solution, which increases the accuracy of the solution by changing the elements, it should be noted that only the shell elements are changed. Since displacement quantities converge quickly (Independent of element size), this quantity is not suitable for checking the convergence of the solution and for this purpose, the Von Mises stress quantity is used. The default size of the mesh and element in the die, mold, and holder are considered by Abaqus software, and the mesh size for the sheet metal workpiece convergence process is performed and the values obtained are shown in Table (2). To analyze the solution convergence in the model, mesh size sheet metal was varied according to Table (2), and the percentage of error obtained is shown in Fig. (6). According to Table (2) and Fig. (6), it is seen that, for element sizes of 8 and 4, mm, the solutions converged. As such, based on the above results and the percentage of error obtained, the optimum element size in sheet metal is considered to be 4mm.

Table 2: The solution convergence in on mesh size

Mesh size (mm)	Maximum value of von Mises stress	Convergence and divergence	Error
37	157.7	divergence	-
17	193		%22
8	221.6	convergence	%15
4	237.7		%7

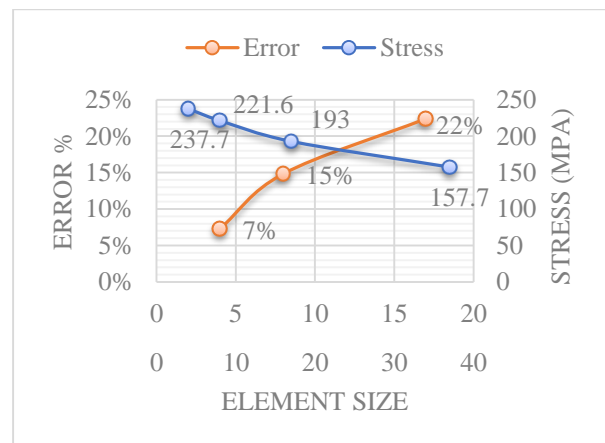

Fig. 6: Solution convergence in on mesh size

Investigation of the Results of Simulation of the Deep Drawing and Rupture of Aluminum Sheet

To achieve the optimal speed for producing a component with suitable and beneficial depth, three different time intervals were considered for the punch movement speed. In order to observe the optimal speed and analyze the DDP of aluminum sheets at the moment when tearing occurs due to stress and pressure in the critical area of the sheet, the modeling process was conducted at three-time intervals of 0.2, 0.7 and 1 m/s. The results are presented in Table (3) and Figs. (7-10).

Table 3: Depth of the specimen at the moment of rupture in aluminum sheets

Depth of the specimen at the moment of rupture (cm)	Punch speed (m/s)
6	1
6.30	0.70
7.22	0.20

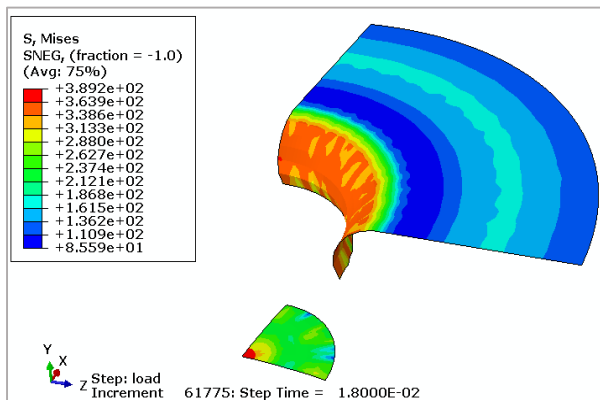

Fig. 7: The moment of rupture initiation in the sheet at a punch speed of 1 m/s

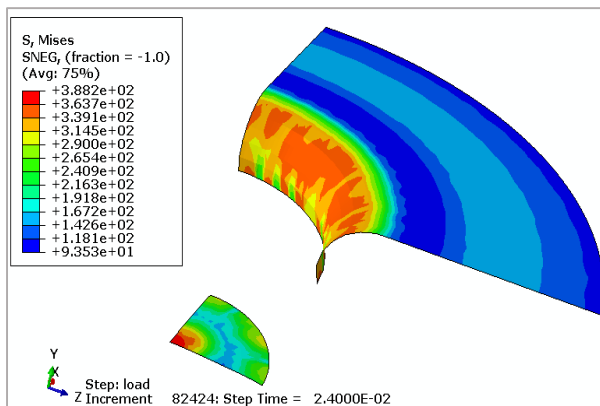

Fig. 8: The moment of rupture initiation in the sheet at a punch speed of 0.7 m/s

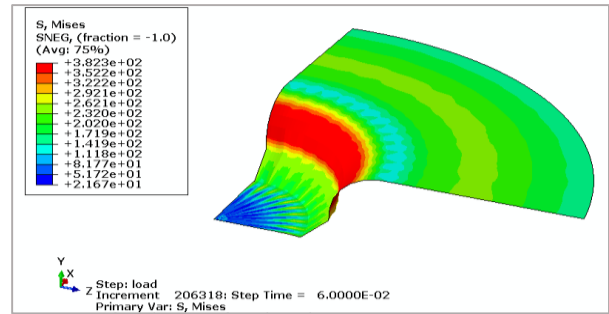

Fig. 9: The moment of rupture initiation in the sheet at a punch speed of 0.2 m/s

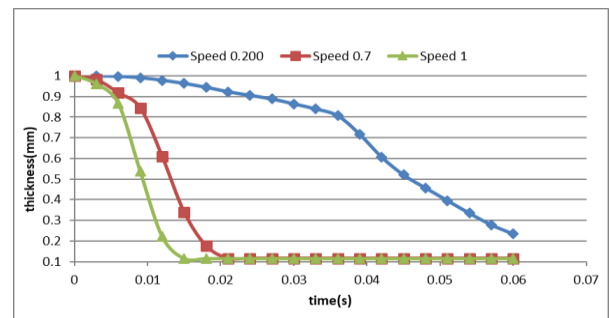

Fig. 10: Sheet thickness reduction at different Punch speeds

Based on Figure (10) and considering the appropriate thickness reduction in the above analysis, it was determined that reducing the punch speed allows for the creation of a deeper specimen. Additionally, taking into account time constraints and economic feasibility, it can be concluded that the optimal speed for producing a specimen from this type of sheet, according to Table (3) and the graph, is 0.20 meters per second. This speed has been adopted as the optimal speed in this study and all other calculations are based on this speed. The modeling process was designed and executed in three different punch speed scenarios and the moment of rupture in the sheet at various speeds was observed as follows.

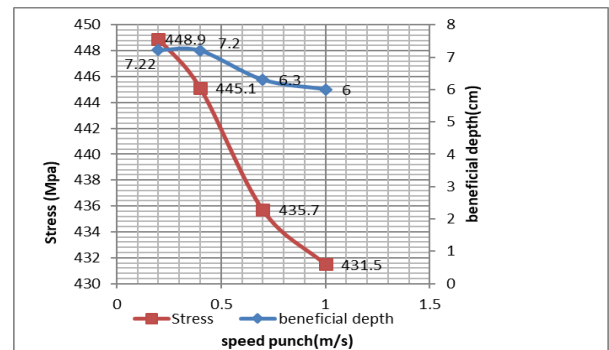

Fig. 11: The comparison of the depth of the sheet and the maximum stress contour at different punch speeds

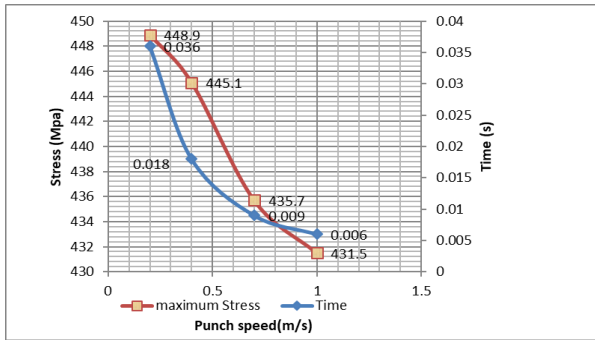

Fig. 12: The time for the rupture process and the maximum stress contour at different punch speeds

The Fig. (11) illustrates that with an increase in punch speed, there is not only a reduction in stress tolerance of the aluminum sheet but also a decrease in the forming depth.

The Fig. (12) shows that as the punch speed increases, the stress tolerance in the aluminum sheet decreases, which leads to a reduction in the DDP time. Based on the observations drawn from the aforementioned graphs and figures, it can be noted that increasing the punch speed during the DDP of the aluminum sheet leads to rupture and the formation of wrinkles.

Results and Discussion

To evaluate the impact of friction on the reduction of piece thickness, it is necessary to analyze the influence of friction between three areas, which are as follows:

1. Frictional interaction between the Punch and the Aluminum sheet
2. Frictional interaction between the Holder and Aluminum sheet
3. Frictional interaction between the Aluminum sheet and the Die

It should be mentioned that, according to the research conducted in this area, changes in the level of friction interaction between the punch and the Aluminum sheet have no significant effect on the results obtained from the analysis. Therefore, the friction condition between the Punch and the Aluminum sheet is considered to be ideal (0.1).

The Effect of Frictional Interaction between the Sheet and the Holder on the Thickness of the Aluminum Sheet

To investigate the effect of frictional interaction between and holder and the aluminum sheet, four different friction values (0.08, 0.16, 0.25 and 0.45) were considered and analyzed, with the results shown in Figs. (13-14) as follows.

As indicated by the results obtained, to create a part

with a specified depth, the friction parameter between the holder and the aluminum sheet has little effect on the thickness of the produced sheet part. By reducing the friction between the holder and the aluminum sheet, it is possible to produce a part with a thicker sheet. Therefore, the optimal friction in these four cases is equal to 0.08.

The Effect of Frictional Interaction between the Die and Aluminum Sheet on the Reduction of Thickness

To investigate the effect of friction interaction between the die and aluminum sheet, friction was considered in four values (0.05, 0.1, 0.3 and 0.5) and results shown in Fig. (15) as follows.

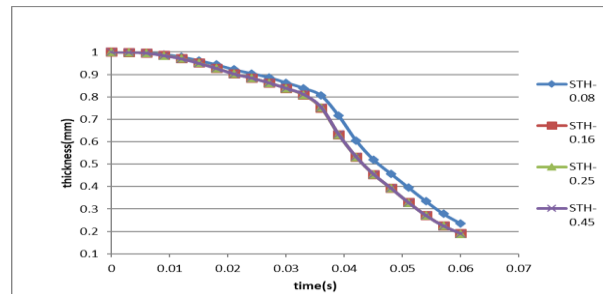

Fig. 13: The trend of thickness reduction of the workpiece sheet at different Friction

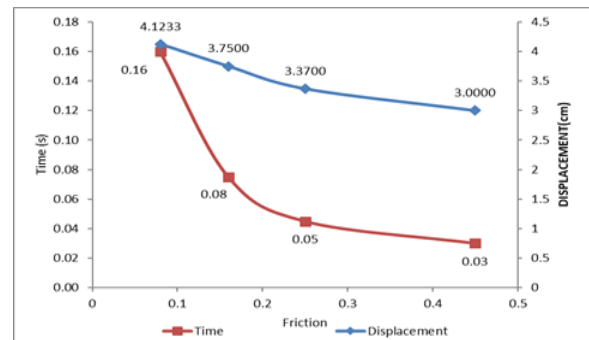

Fig. 14: The comparison of the time for the rupture process and the depth of the sheet at different friction

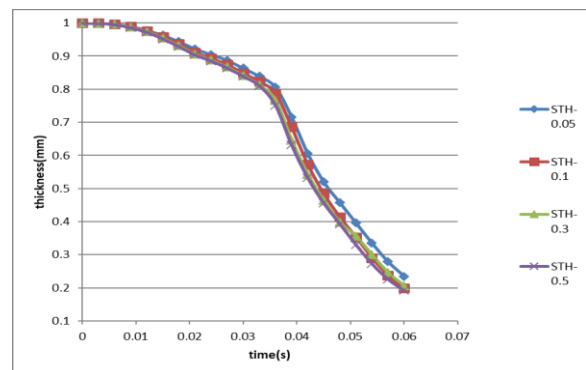

Fig. 15: The trend of thickness reduction of the workpiece sheet at different friction

As indicated by the obtained results, to create a part with a specified depth, the friction parameter between the die and aluminum Sheet has a significant impact on the thickness of the produced sheet part. Increasing the friction between the die and aluminum She *et al.* lows for the production of a part with a thicker sheet. It can also be concluded that the increase in friction between the sheet and the die has a greater effect on producing a part with more depth and thickness compared to the friction between the holder and the aluminum sheet. Therefore, the optimal friction in these four cases is 0.5.

Conclusion

Results Related to Punch Speed in Aluminum Sheet

By examining and analyzing the effects of speed parameters in the DDP of aluminum sheet to determine the optimal speed for producing parts with useful depth, it was concluded that increasing the punch speed leads to a smaller useful depth in the DDP. Conversely, with a decrease in the punch speed across the three examined ranges, it was established that lowering the speed yields a greater useful depth in the DDP, ultimately producing parts with greater depth. It is worth noting that, according to the definition of the failure criterion in the modeling of the DDP, the useful depth of the work piece is considered at the moment just before tearing. However, it is essential to consider time constraints and economic efficiency in this process to achieve the most optimal production conditions, as excessively reducing the speed does not practically provide ideal production conditions. Additionally, this study revealed that by reducing the punch speed, a thicker part can be produced at a specific depth, and for producing a part of a specified depth (1 Millimeter), the lower the punch speed, the greater the thickness of the sheet will be. It should be clarified that, according to the definition of the failure criterion in the modeling of the DDP, the reduction in thickness of the work piece sheet is calculated up to the moment of sheet tearing.

Results Related to Friction Interaction between the Holder and Aluminum Sheet

Based on the investigation conducted in this research, four specific friction ranges were considered to achieve a beneficial depth just before tearing. After analysis using the Abaqus software, it was determined that by reducing the friction interaction between the Holder and the aluminum sheet in the DDP, a part with greater useful depth and less wrinkling and tearing could be produced. It is important to note that, in this study, "beneficial depth" refers to the depth achieved in the part just before tearing.

Therefore, it can be concluded that to produce a part with greater depth and less wrinkling, the friction between the Holder and the aluminum sheet should be minimized.

Results Related to Friction Interaction between the Die and the Aluminum Sheet

In relation to the friction interaction between the die and the aluminum sheet, four friction ranges were also investigated in this study. The results obtained from the analysis and the graphs produced in the Abaqus software indicated that the maximum effect of friction in the cases examined occurred when a friction level of 0.5 was considered. Following the analysis, it was found that by increasing the friction between the die and the aluminum sheet in the DDP, a part with greater useful depth could be created without showing any wrinkling or tearing.

Acknowledgment

We sincerely thank the publisher for their invaluable support in publishing this research article, providing essential resources and a platform to share our findings. We also appreciate the editorial team's efforts in refining our work and we are honored to contribute to the field through this publication.

Funding Information

The authors declare no financial support or funding for this study.

Author's Contributions

Ehsan Hedayati: Contributed to the conceptualization, modeling, simulation, data analysis, literature review, report organization, manuscript drafting, writing, and provided final approval.

Arefeh Hedayati: Participated in the literature review, data analysis, report organization, study organization, and manuscript writing.

Mohammad Vahedi: Engaged in the literature review, report review, research guidance, study organization, and manuscript editing and writing.

Shirko Faroughi: Involved in the literature review, report review, research guidance, study organization, and manuscript editing and writing.

Ethics

This original, unpublished document certifies that all co-authors have read and approved the manuscript and there are no ethical concerns.

References

- Abaqus. (2017). *SIMULIA Abaqus 6.14 Documentation*.
<https://classes.engineering.wustl.edu/2009/spring/mase5513/abaqus/docs/v6.6/books/usb/default.htm?startat=pt05ch19s02abm38.html>
- Amini, A., Moslemi Naeni, H., Deilami Azodi, H., Talebi-Ghadikolaee, H., Badparva, H., & Zeinolabedin-Beygi, A. (2024). Hydro-Mechanical Deep Drawing of Conical Components: Wrinkling Behavior and Process Enhancement. *Journal of Engineering Research*, 2307-1877.
<https://doi.org/10.1016/j.jer.2024.04.005>
- Chung, S. Y., & Swift, H. W. (1951). Cup-Drawing from a Flat Blank: Part I. Experimental Investigation. *Proceedings of the Institution of Mechanical Engineers*, 165(1), 199211.
https://doi.org/10.1243/pime_proc_1951_165_021_02
- Cser, L. (1991). A Generalized Life-Time Model for Cold Extrusion Tools. *CIRP Annals*, 40(1), 299–301.
[https://doi.org/10.1016/s0007-8506\(07\)61991-x](https://doi.org/10.1016/s0007-8506(07)61991-x)
- Gürün, H., & Karaağaç, İ. (2015). The Experimental Investigation of Effects of Multiple Parameters on the Formability of the DC01 Sheet Metal. *Strojniški Vestnik - Journal of Mechanical Engineering*, 61(11), 651-662.
<https://doi.org/10.5545/sv-jme.2015.2562>
- Hessenberg, W. C. (1954). *A simple Account of Prof.*
- Hosford, W. F., & Caddell, R. M. (2011). *Metal Forming: Mechanics and Metallurgy*.
<https://doi.org/https://books.google.com.pk/books?i d=x0GWAd7hNy0C>
- Hu, S. J., Marciniak, Z., & Duncan, J. L. (2002). *Mechanics of Sheet Metal Forming*. Elsevier.
- Jensen, M. R., Damborg, F. F., Nielsen, K. B., & Danckert, J. (1998). Applying the Finite-Element Method for Determination of Tool Wear in Conventional Deep-Drawing. *Journal of Materials Processing Technology*, 83(1-3), 98-105.
[https://doi.org/10.1016/s0924-0136\(98\)00047-8](https://doi.org/10.1016/s0924-0136(98)00047-8)
- Kolahdooz, R., Asghari, S., Rashid-Nadimi, S., & Amirfazli, A. (2017). Integration of Finite Element Analysis and Design of Experiment for The Investigation of Critical Factors in Rubber Pad Forming of Metallic Bipolar Plates for PEM Fuel Cells. *International Journal of Hydrogen Energy*, 42(1), 575-589.
<https://doi.org/10.1016/j.ijhydene.2016.11.020>
- Kim, H. S. (2010). A Combined FEA and Design of Experiments Approach for the Design and Analysis of Warm Forming of Aluminum Sheet Alloys. *The International Journal of Advanced Manufacturing Technology*, 51(1-4), 1–14.
<https://doi.org/10.1007/s00170-010-2620-8>
- Önder, E., & Tekkaya, A. E. (2008). Numerical Simulation of Various Cross Sectional Workpieces Using Conventional Deep Drawing and Hydroforming Technologies. *International Journal of Machine Tools and Manufacture*, 48(5), 532–542.
<https://doi.org/10.1016/j.ijmactools.2007.06.012>
- Paul, S. K., Manikandan, G., & Verma, R. K. (2013). Prediction of Entire Forming Limit Diagram from Simple Tensile Material Properties. *The Journal of Strain Analysis for Engineering Design*, 48(6), 386–394.
<https://doi.org/10.1177/0309324713488886>
- Safdarian, R., Jorge, R. M. N., Santos, A. D., Naeni, H. M., & Parente, M. P. L. (2015). A Comparative Study of Forming Limit Diagram Prediction of Tailor Welded Blanks. *International Journal of Material Forming*, 8(2), 293-304.
<https://doi.org/10.1007/s12289-014-1168-9>
- Sheng, Z. Q., Taylor, R., & Strazzanti, M. (2008). FEM-Based Progressive Drawing Process Design. *The International Journal of Advanced Manufacturing Technology*, 36(3-4), 226-236.
<https://doi.org/10.1007/s00170-006-0829-3>
- Singh, S. K., & Gupta, A. K. (2010). Application of Support Vector Regression in Predicting Thickness Strains in Hydro-Mechanical Deep Drawing and Comparison with ANN and FEM. *CIRP Journal of Manufacturing Science and Technology*, 3(1), 66–72.
<https://doi.org/10.1016/j.cirpj.2010.07.005>
- Sowerby, R., Duncan, J. L., & Chu, E. (1986). The Modelling of Sheet Metal Stampings. *International Journal of Mechanical Sciences*, 28(7), 415-430.
[https://doi.org/10.1016/0020-7403\(86\)90062-7](https://doi.org/10.1016/0020-7403(86)90062-7)
- Yang, D. Y., & Kim, Y. J. (1986). A Rigid-Plastic Finite-Element Formulation for The Analysis of General Deformation of Planar Anisotropic Sheet Metals and Its Applications. *International Journal of Mechanical Sciences*, 28(12), 825-840.
[https://doi.org/10.1016/0020-7403\(86\)90029-9](https://doi.org/10.1016/0020-7403(86)90029-9)
- Zhang, S. H., Lang, L. H., Kang, D. C., Danckert, J., & Nielsen, K. B. (2000). Hydromechanical Deep-Drawing of Aluminum Parabolic Workpieces—Experiments and numerical simulation. *International Journal of Machine Tools and Manufacture*, 40(10), 1479–1492
[https://doi.org/10.1016/s0890-6955\(00\)00006-7](https://doi.org/10.1016/s0890-6955(00)00006-7)